

# Cellular Vertical

## Installation and Care Guide

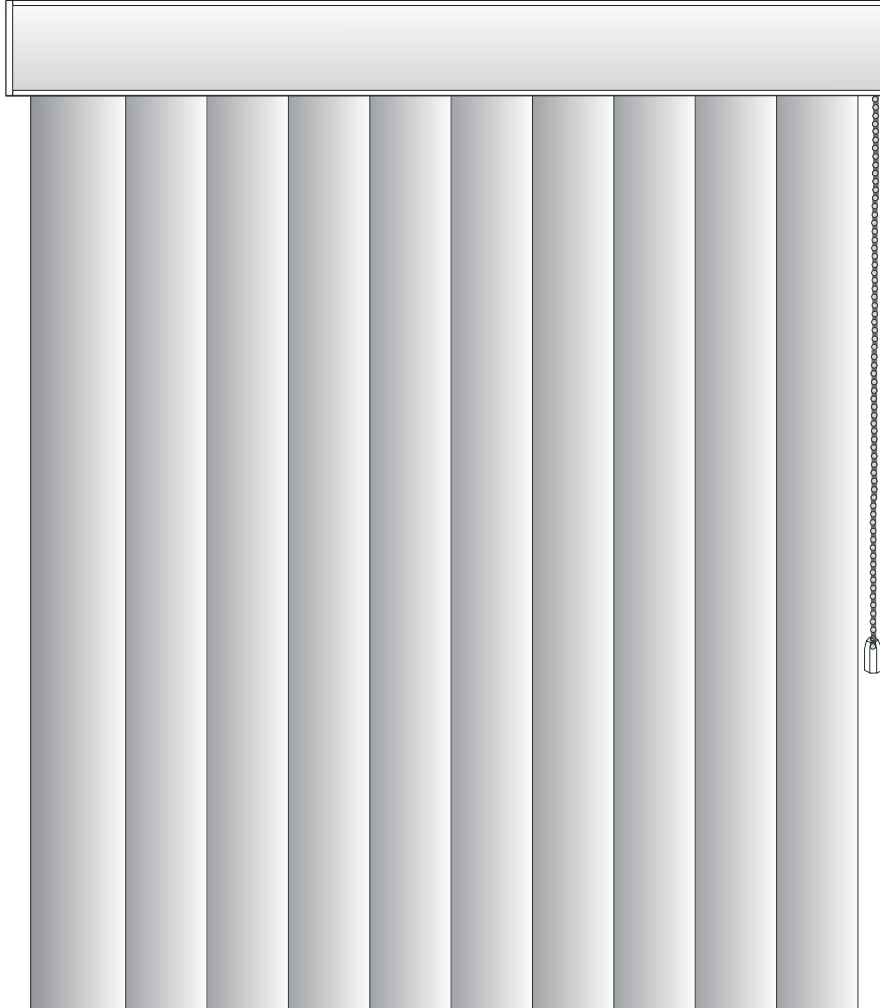

Cellular Vertical Blinds represent a design breakthrough in style, efficiency and function. The unique fabric structure and hardware system are designed to provide years of reliable service when properly installed.

**Please take a few minutes to read through these instructions before beginning.**

Keep these instructions for  
future reference

## I BASICS

A few simple tools are required:

- Measuring tape
- Power drill, drill bits
- Hex head and/or Phillips driver bit
- Pencil
- Level

Additional fasteners other than those sent with your blind may be required depending on the mounting surface. Wallboard and plaster require the use of anchors such as expansion or toggle bolts. Brick, tile or stone need special plugs and drill bits. Remember to always pre-drill holes in wood to avoid splitting.

## II HARDWARE

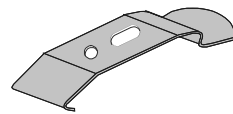

Inside Mount Clip for Traditional Valance

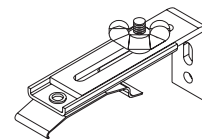

Outside Mount Bracket for Fascia and Traditional Valance

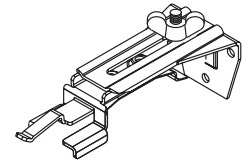

Outside Mount Bracket for Aluminum Valance

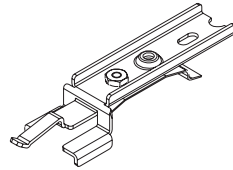

Inside Mount Bracket for Aluminum Valance

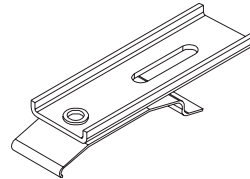

Inside Mount Bracket for Fascia

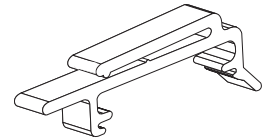

Outside Mount Valance Hanger for Traditional Valance



1 1/4" Hex Head

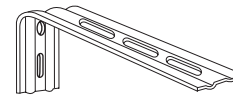

Extension Bracket (Used for Side Mounting)



3/4" Round Head Tensioner Screw

## III BRACKET INSTALLATION

### Basics

Choose the appropriate mounting option for your application. End brackets should be located with centerlines 4" in from each end. Additional brackets should be spaced no more than 30" apart. Valance hangers should be spaced 1" off of each mounting bracket. One hanger per bracket.

**Important:** for blinds with Fascias, mounting brackets must be placed so that they do not interfere with the clips on the fascia. Measure and mark positions of fascia clips prior to installing mounting brackets.

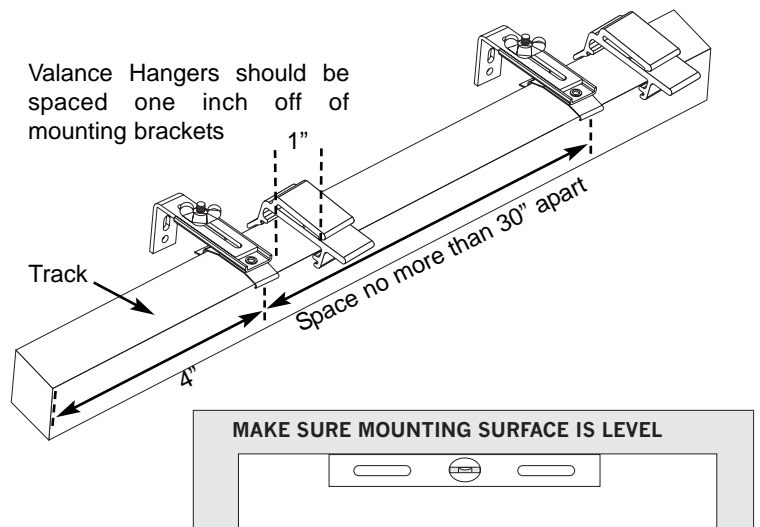

The mounting surface must be level for the vertical blind to operate correctly. The brackets may need to be shimmed for out of level windows.

### 1. Inside Mount

#### Aluminum Valance and Fascia

The back of the mounting bracket must be 1/8" from any obstruction.

Temporarily rotate mounting clip to install the back screw. When repositioning the clip, make sure that the rivet used to attach the clip is all the way to the back of the slot.

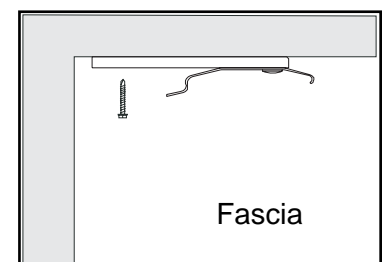
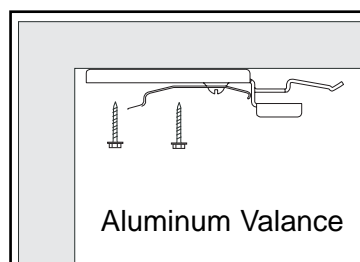

Designer Valance

Align screw through the front hole of the Inside Mount Bracket and the center groove of the Designer Valance swivel bracket. Slide the bottom groove of the bottom of the valance onto the swivel bracket. Rotate the top of the valance towards the swivel bracket. While pushing against the top of the valance reach behind the valance and pull down on locking mechanism. Check to make sure that the top groove is locked in place.

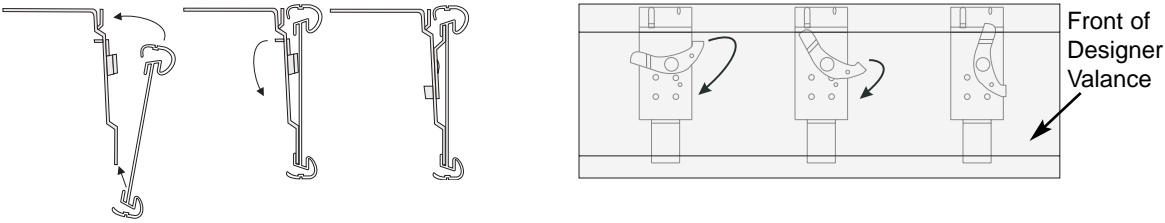
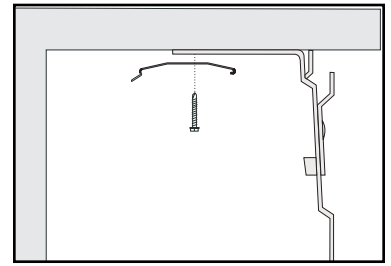

Traditional Valance

*Valance must be assembled before installation. See instructions in section IX.*

Align screw through the front hole of the Inside Mount Bracket and the center groove of the Traditional Valance.

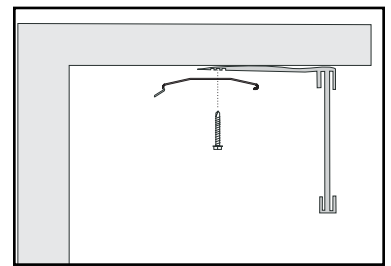

**2. Side Mount**

Bolt an inside mount bracket to an extension bracket as shown.

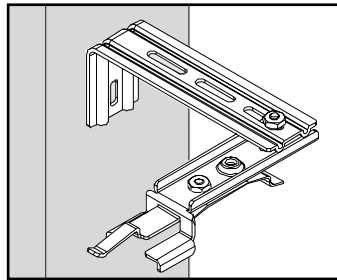

Aluminum Valance

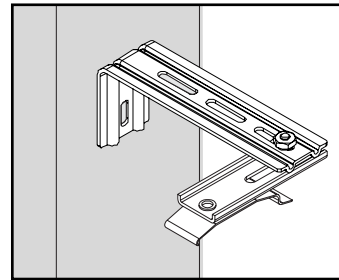

Fascia, Traditional, and Designer

**3. Outside Mount**

Position the mounting bracket at the desired height. Place a screw through the center of the slotted hole on the mounting bracket and secure into the mounting surface. Make sure that all mounting brackets are level. Secure brackets with a second screw through the round hole.

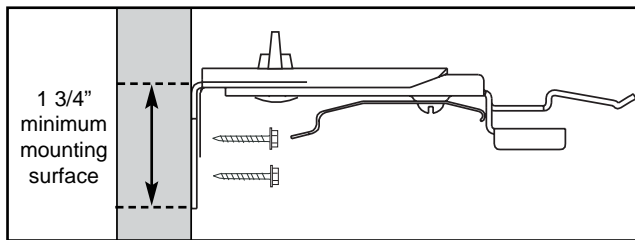

Aluminum Valance

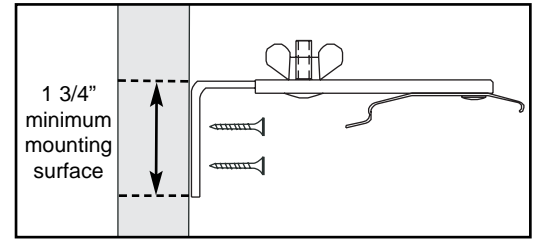

Fascia, Traditional, and Designer

**IV TRACK INSTALLATION**

Insert the front groove of the track into the front of the mounting clip, then push the back of the rail up to snap into the back of the mounting clip.

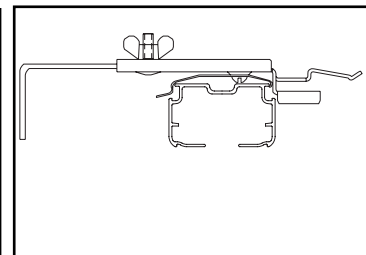
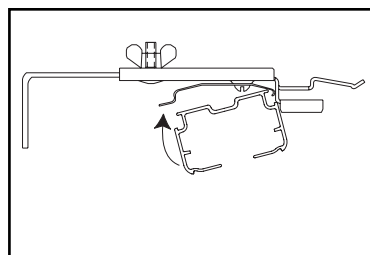

## V CORD TENSIONER INSTALLATION - FOR BLINDS WITH CORD CONTROL

The cord tensioning device is necessary for child safety and for proper operation of the blind. The cord may droop from the track if the tensioner is not installed.

1) Choose the best mounting location for the specific installation. The tensioning device may be mounted to the sill, to the jamb or to the wall.

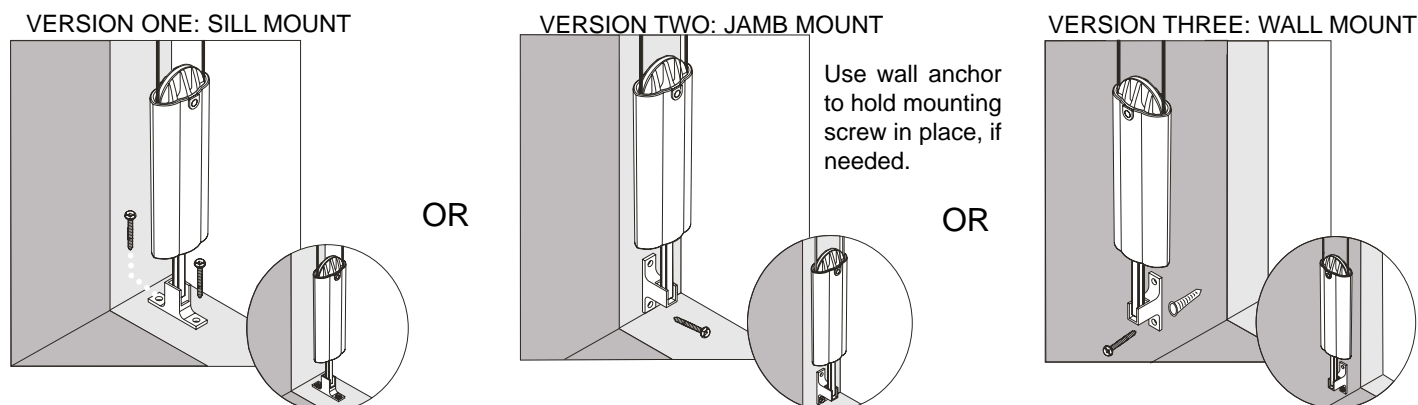

2) Fully extend tensioning device. Lock into extended position by rotating the post 45 degrees.

3) Hold the cord tensioner at the desired mounting position with the cord taut and the cord tensioning device in extended position. Screw the tensioning device to the mounting surface. If the specific installation requires that the cord tensioning device be placed in a position so that there is not tension on the cord, the cord length will need to be adjusted (see Cord Adjustment below).

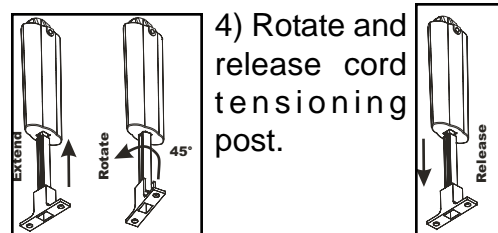

## VI CORD LENGTH ADJUSTMENT

If the cord droops from the track or if the cord is not taut when the tensioning device is installed, the cord length will need to be adjusted.

### A. Side Stack

To reduce cord length on Side Stack:

- 1) Operate the track so that the carriers are in the stacked position.
- 2) Locate 1/2" cord tail in front of lead carrier.
- 3) Loosen adjusting screw, just enough to be able to pull the cord. If loosened too much the other cord may slip out of position.
- 4) Pull cord tail until the cord has the proper tension.
- 5) Tighten adjusting screw. Make sure to tighten enough to prevent the cords from slipping.
- 6) Cut excess cord.

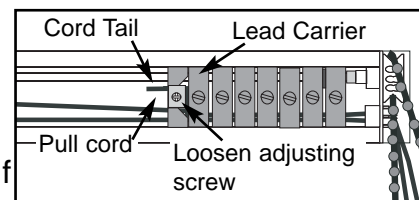

### B. Split Stack

To reduce cord length on Split Stack:

- 1) Place the carriers in the closed position.
- 2) Locate cord tails in front of lead carrier on the side of the track opposite the control.
- 3) Loosen adjusting screw, just enough to be able to pull the cord. If loosened too much the other cord may slip out of position.
- 4) Select a 1/2" cord tail and pull slightly. If any carrier movement is observed **stop**. Select the other cord. **Caution** - cutting the wrong cord will cause irreparable damage.
- 5) Pull the cord tail until the cord has the proper tension.
- 6) Tighten the adjusting screw. Make sure to tighten enough to prevent the cords from slipping.
- 7) Cut excess cord.

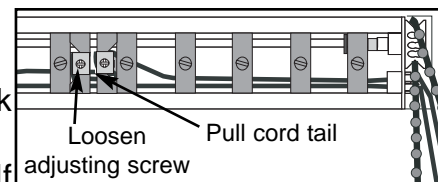

## VII VANE INSTALLATION

If removal of the vanes are necessary during the installation process see section VIII for the proper removal procedure.

Hold the vane with the colored side of the vane facing the desired direction (right or left). Hold the vane at the base of the vane clip. Attach the vane by sliding the cross bar of the vane clip into the carrier.

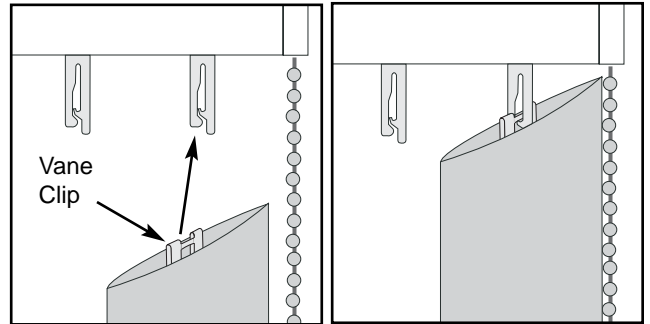

If the color direction needs to be changed, the vanes must be removed from the carrier and reinstalled. Do not change color direction by reversing the direction that the vanes overlap while closed. The vanes will not rotate if overlapped in the wrong direction.

## VIII. REMOVAL OF VANES FROM CARRIERS -

(This step is needed only if a vane needs to be repositioned during install or for cleaning, or replacement)

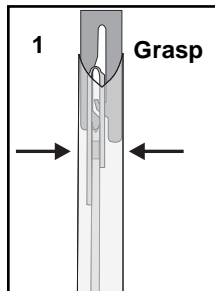

1 Grasp vane and vane clip.

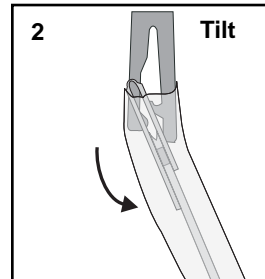

2 Tilt vane clip so that the top of the clip pushes against the short side of the carrier stem. You should hear an audible click.

## IX TOP TREATMENT

### A. Designer Valance

Inside Mount valance must be installed with bracket clips in Section III.

#### Outside Mount Assembly

1. Attach Corner Connectors to each end of the valance.
2. Slide the fabric insert strip into the valance face.
3. Slide the fabric insert into the returns.
4. Rotate the return, keeping the fabric strip at least part way in the return.
5. Slide the return onto the corner connector.
6. The Fabric Insert Strip will overhang 1/2" on each end. Wrap ends of fabric around the back of the return and secure with tape.

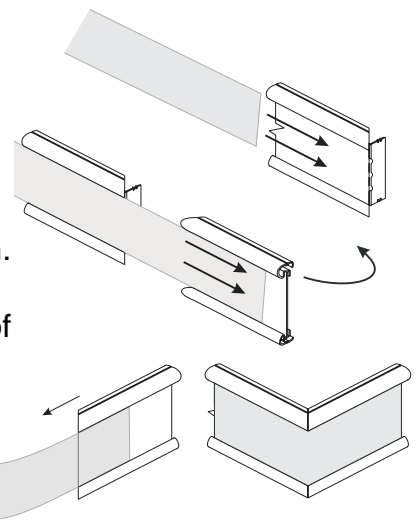

#### Inside Mount Assembly

Follow steps 2 and 6 of outside mount. On step 6, attach the fabric to the back of the valance without any returns.

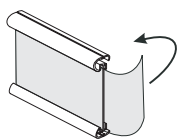

#### Outside Mount Installation

Hold valance in front of the Cellular Vertical and position where desired horizontally. The back of the flat-top of the swivel bracket will be inserted into the clip on the valance hanger. Once the valance is aligned properly insert the edge into the clip on the valance hanger and press firmly until the edge of the swivel bracket is all the way back in the clip.

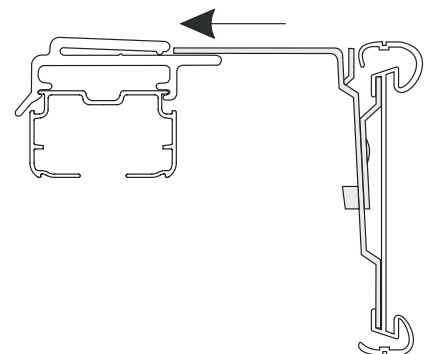

## B. Traditional Valance

*Inside Mount valance must be installed with bracket clips in Section III.*

### Outside Mount Assembly

1. Attach rounded Corner Connectors to each end of the valance.
2. Slide the fabric insert strip into the valance face.
3. Slide the fabric insert into the returns.
4. Rotate the return, keeping the fabric strip at least part way in the return.
5. Slide the return onto the corner connector.
6. Snap the corner covers into place.
7. The Fabric Insert Strip will overhang 1/2" on each end. Wrap ends of fabric around the back of the return and secure with tape.

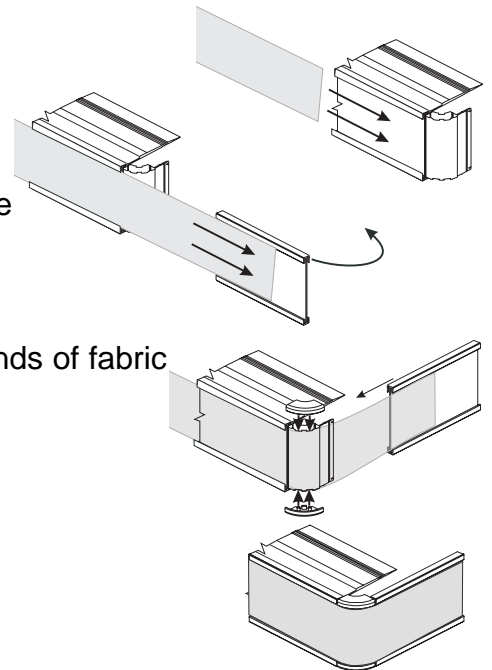

### Inside Mount Assembly

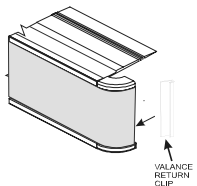

Follow steps 1, 2, 6 and 7 of outside mount. On step 7, the return clips will attach the fabric to the ends of the corner connectors.

### Outside Mount Installation

Hold valance in front of the Cellular Vertical and position where desired horizontally. The back of the flat-top of the valance will be inserted into the clip on the valance hanger. Once the valance is aligned properly insert the edge into the clip on the valance hanger and press firmly until the edge of the valance is all the way back in the clip.

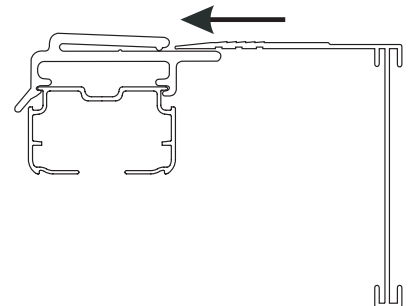

## C. Aluminum Valance

Do not remove protective film until installation is complete. Install the track and vanes before attaching the valance

### 1. Assembly

If the valance comes with returns, snap the returns onto the ends of the valance as shown.

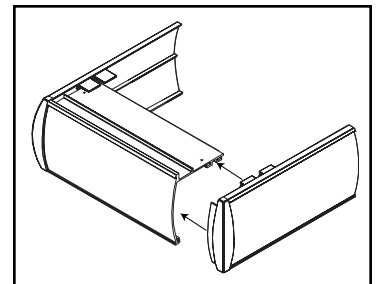

### 2. Installation

Hold valance in front of the Cellular Vertical and position where desired horizontally. The back of the flat-top of the valance will be inserted into the front of the bracket. Once the valance is aligned properly insert the edge into the bracket and press firmly until the edge of the valance is all the way in.

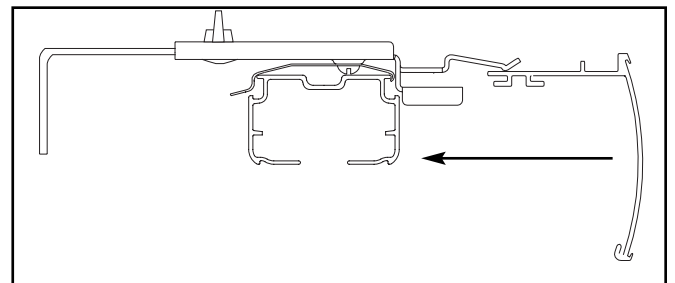

## D. Wood Fascia (outside mounts)

Install the track before attaching the fascia. Attach the fascia to the track as shown.

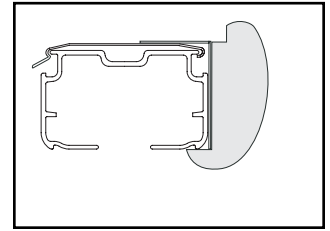
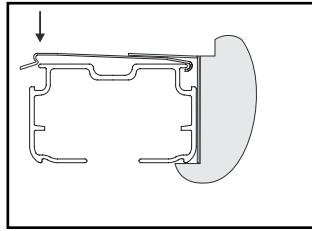
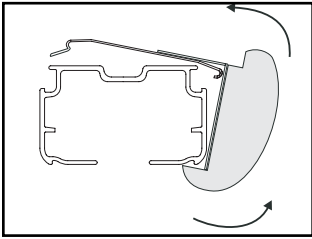

## D. Wood Fascia (inside mount)

Install the track before attaching the fascia.

Hold the fascia in position. Press the Dual-Lock pieces on the back of the Fascia to the Dual-Lock on the track.

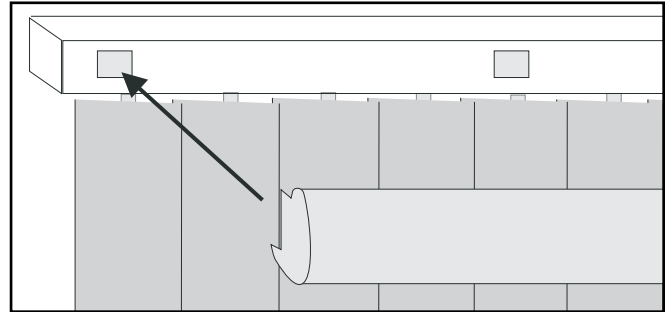

## X OPERATION

### Cord/Chain Control

Pull the bead chain to rotate the vanes.

Pull the traverse cord to move the vanes to and from the stacked position.

## XI CLEANING & CARE

All parts of the Cellular Vertical can be cleaned with a feather duster or a standard vacuum. We recommend doing either of the two regularly to keep your Cellular Vertical looking new.

Spills and stains can be lightly blotted with a cloth or damp sponge. More difficult stains may require gentle washing in water with mild soap. For this, remove the vanes from the carriers (see section VIII), remove the inserts from the vane pocket (see section XII) and submerge, soak and rub lightly. Lay flat to dry or place back in window.

To iron or fully wash the vanes, remove the vanes from the carriers (see section VIII). Remove the plastic inserts from the pocket of the fabric sleeves (see section XII).

The colored fabric sleeves can be ironed if they become wrinkled. **Remove the plastic vane insert from the fabric sleeve pocket before ironing the vane.** Iron the vane at level 2, or the "silk" setting on a household iron.

Cellular Verticals can be ultrasonically cleaned.

## XII REMOVAL/INSTALLATION OF VANE INSERTS (only necessary for cleaning)

### Removal

The Vane Inserts can only be removed when the full Vane is unattached from the carriers (see Section VIII). Lay the full Vane on a flat surface. Gently detach the Dual-Lock at the top of the vane, and slide the plastic insert out from the top of the fabric sleeve pocket.

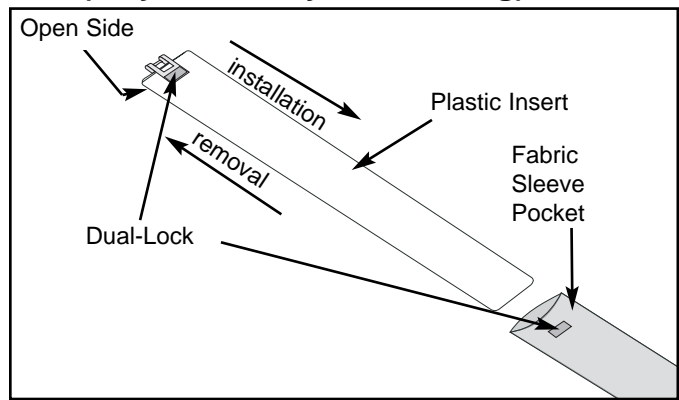

### Installation

Slide the bottom end of the plastic insert into the top of the pocket of the fabric sleeve. Place the bottom corners of the vane clip crossbar at the top of the fabric sleeve (Dual-Lock halves should align). Press the two halves of the Dual-Lock together.

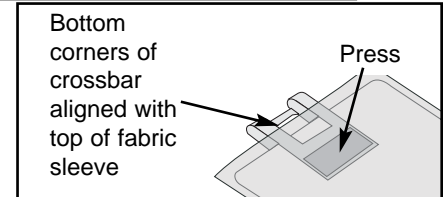

## XIII TROUBLE SHOOTING

- ◆ **Problem:** When the vanes are closed, some vanes do not overlap at the bottom of the blind.  
Cause: Static cling can cause the vanes to hang improperly.  
Repair: Spray the vanes with an anti-stat spray.
- ◆ **Problem:** The backs of the vanes appear puckered.  
Cause: The fabric sleeve is not seated properly.  
Repair: Gently pull down on the fabric sleeve at the bottom, while the insert is in the carrier.  
**Caution:** pulling too hard may damage the vane.
- ◆ **Problem:** When the vanes are closed they slant.  
Cause: The headrail is not level.
  1. The inside mount mounting surface may not be level.
  2. Wings nuts are not allowing the headrail to sit properly in the mounting clip.
  3. Mounting clips slid out of position during bracket installation.Repair 1: Level mounting surface with shims.  
Repair 2: Insert bolt and wing nut so that the wing nut does not interfere with the mounting clip (wing nut should be facing up).  
Repair 3: Slide mounting clip as far forward as it will go in the bracket. The rivet used to attach the clip should be at the back of the slot in the clip.
- ◆ **Problem:** Traverse cord is drooping from the track when the vanes are stacked.  
Cause: Traverse Cord is too long or Cord Tensioner is not set correctly.  
Repair: Move cord tensioner down to create more tension or shorten traverse cord. See cord adjustment section (Section VI) for instructions on adjusting cord length.
- ◆ **Problem:** The vanes no longer rotate; the mechanism appears to be jammed.  
Cause 1: The direction that the vanes overlap was reversed. (i.e. the wind, a child or a pet misaligned some of the vanes and they were realigned with the wrong overlap direction)  
Cause 2: The color direction was changed without removing the vanes from the carrier, resulting in cause 1.  
Repair 1: Manually readjust the overlap of the vanes.  
Repair 2: Remove the vanes (see section VIII) and reinstall in the desired color direction (section VII).